



## ASM Series • Current Sensor for 50/60 Hz

ASM Series current sensors operate as the sealed secondary of a current transformer while the conductor carrying the current to be measured functions as a one turn primary. Measurement accuracy can be improved by increasing the number of primary turns. Applications include detection of branch circuit overload and load drop or shutdown.

### Features

- Fully encapsulated for optimal PC board mtg.
- Mains frequency of 50/60 Hz
- Primary current ratings from 1 to 100 Amps
- Primary to secondary isolated to 2500 VAC
- Operating temperature range: -40° C to +120°C

- Competitive pricing due to high volume production
- Manufactured in an ISO-9001:2000, TS-16949:2002 and ISO-14001:2004 certified Talema facility
- **Fully RoHS compliant**

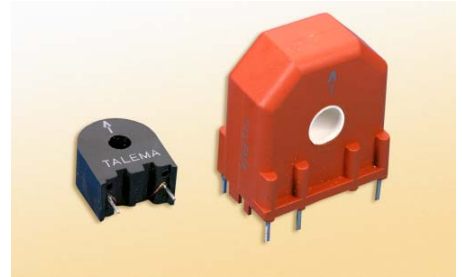

Part Number	Current Range	Output Voltage Tolerance
ASM-010	1 - 10 Amps	±10%
ASM-020	1 - 20 Amps	±10%
ASM-030	1 - 30 Amps	±10%
ASM-050	5 - 50Amps	±10%
ASM-075	5 - 75 Amps	±10%
ASM-100	5 - 100 Amps	±10%

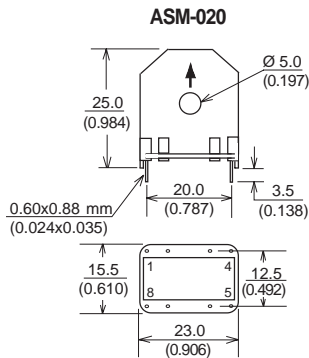

Note: Pins #1 and 8 are Blank

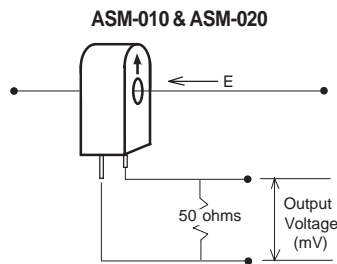
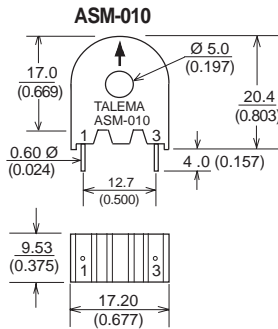

ASM-030

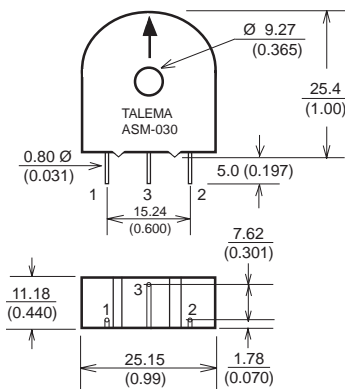

Note: Pin #3 is Blank

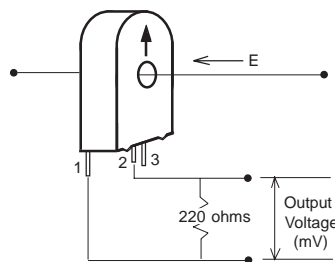

ASM-050, ASM-075 & ASM-100

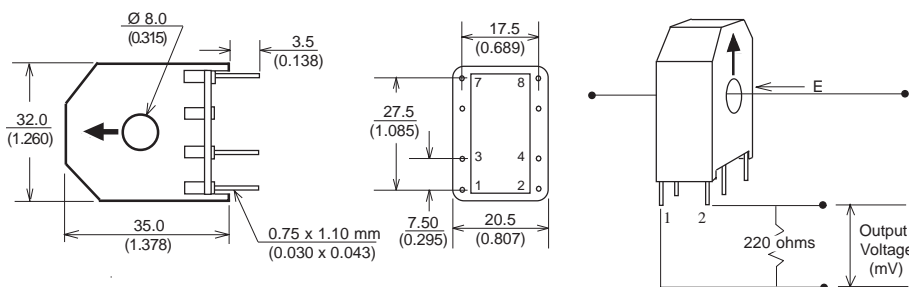

### Typical Response

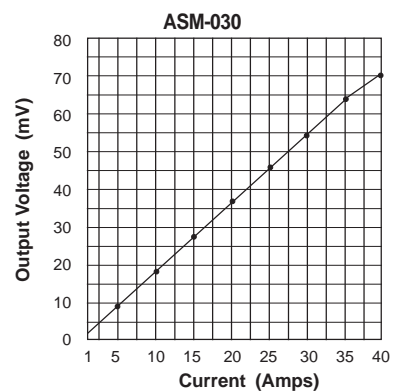
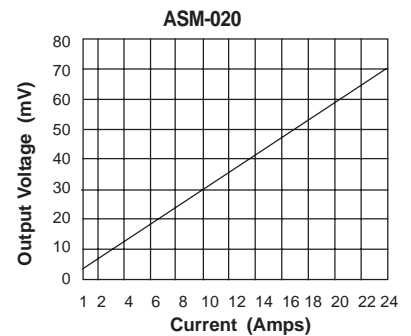
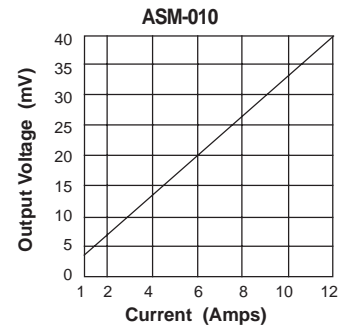

ASM-050, ASM-075 & ASM-100

